

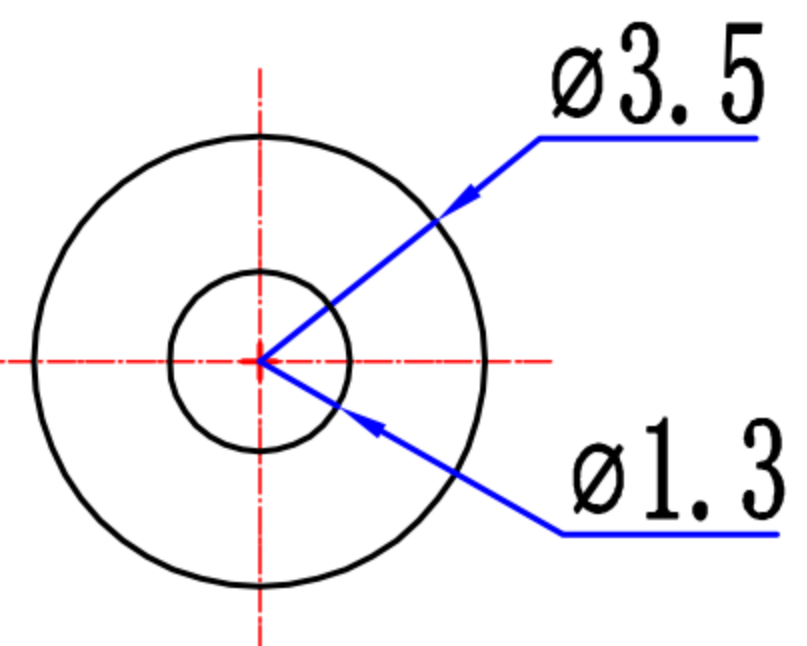

CIRCUIT DIAGRAM

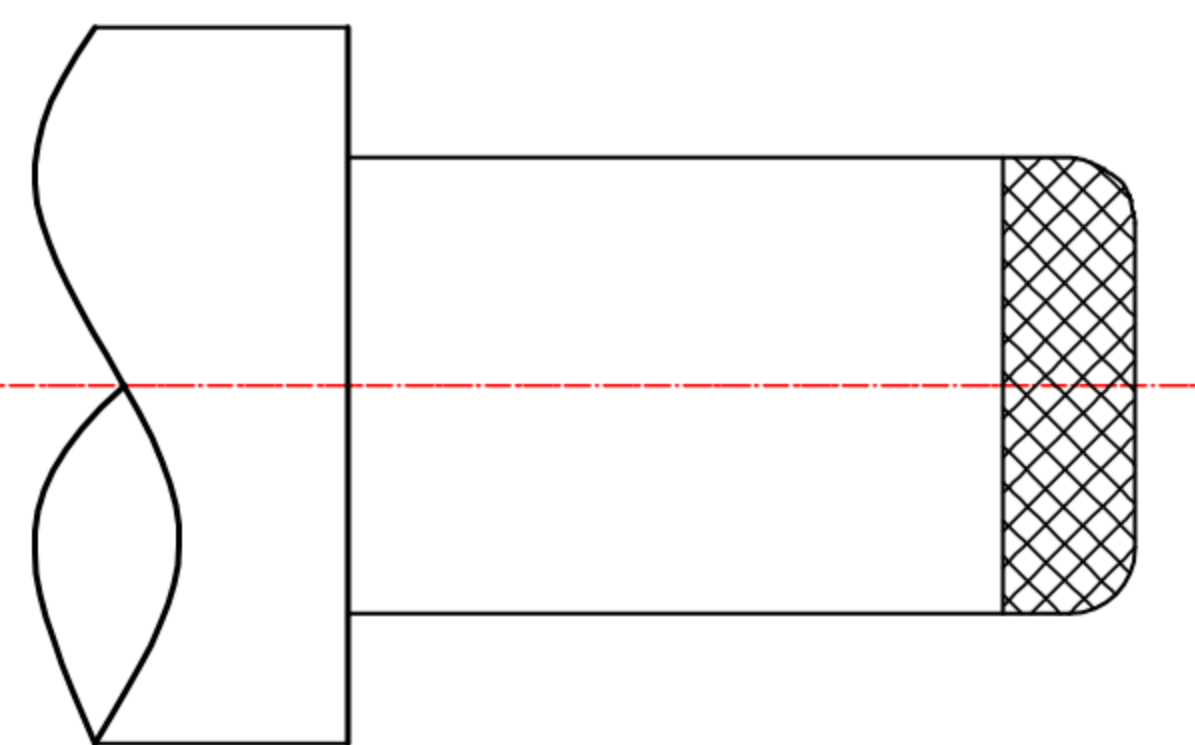
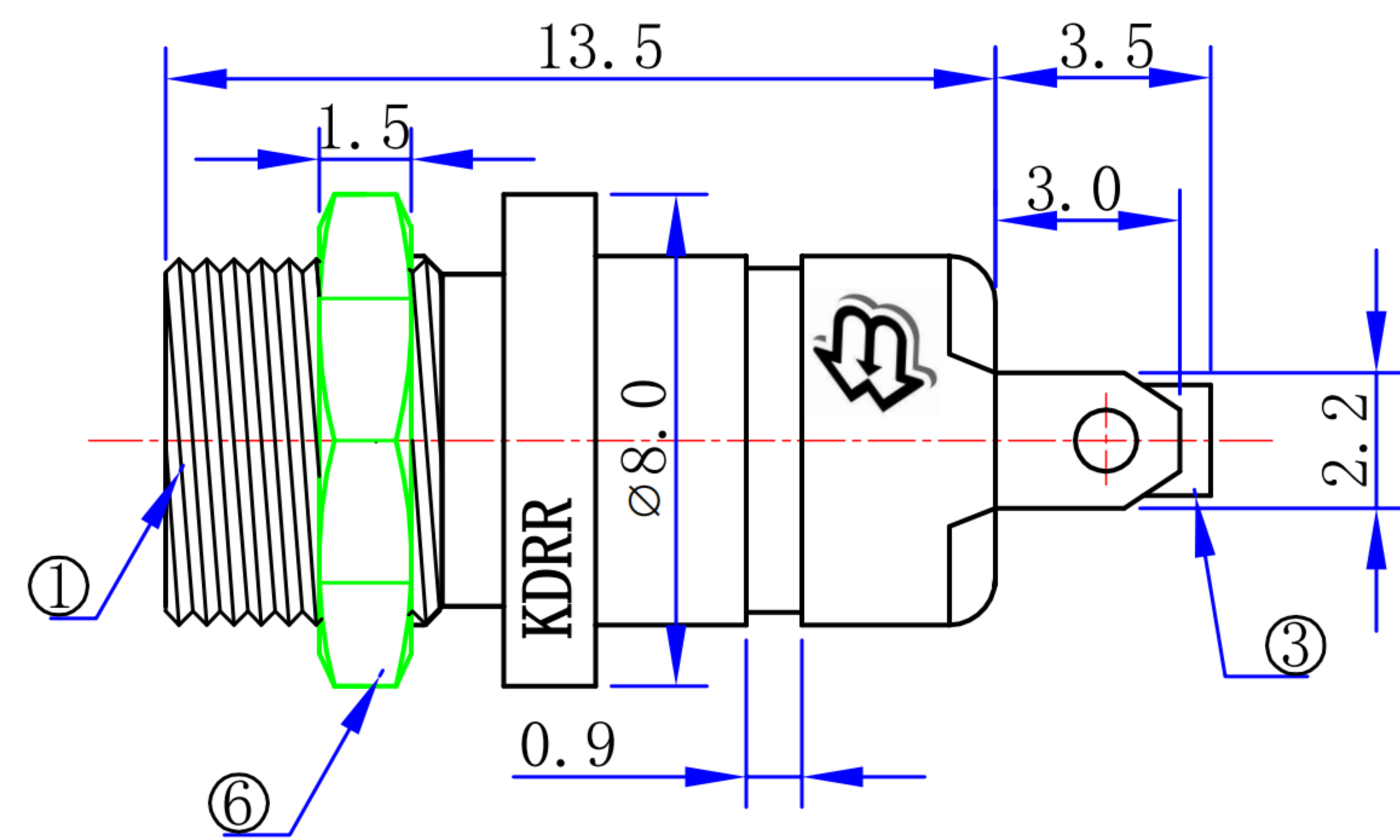
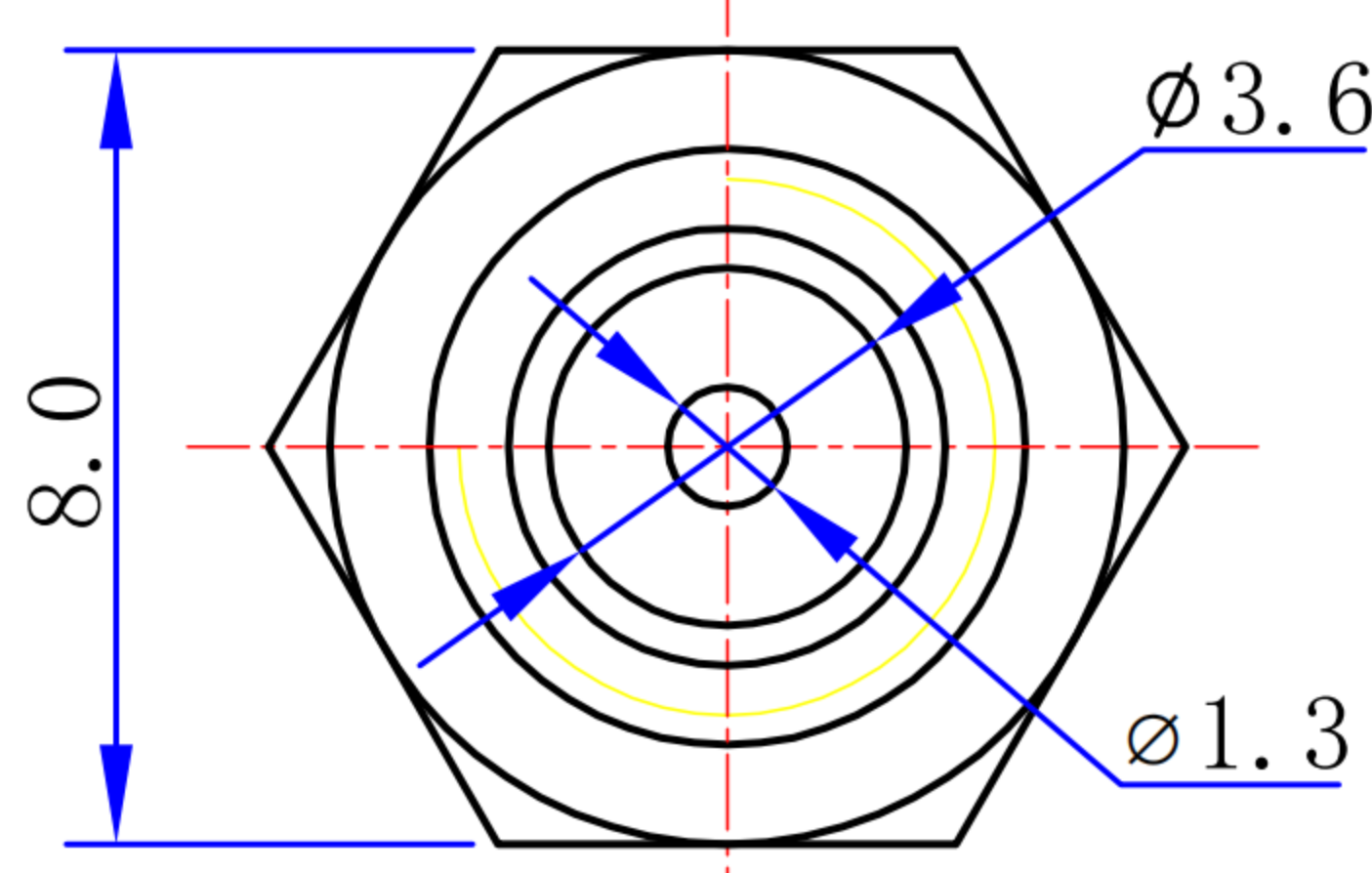
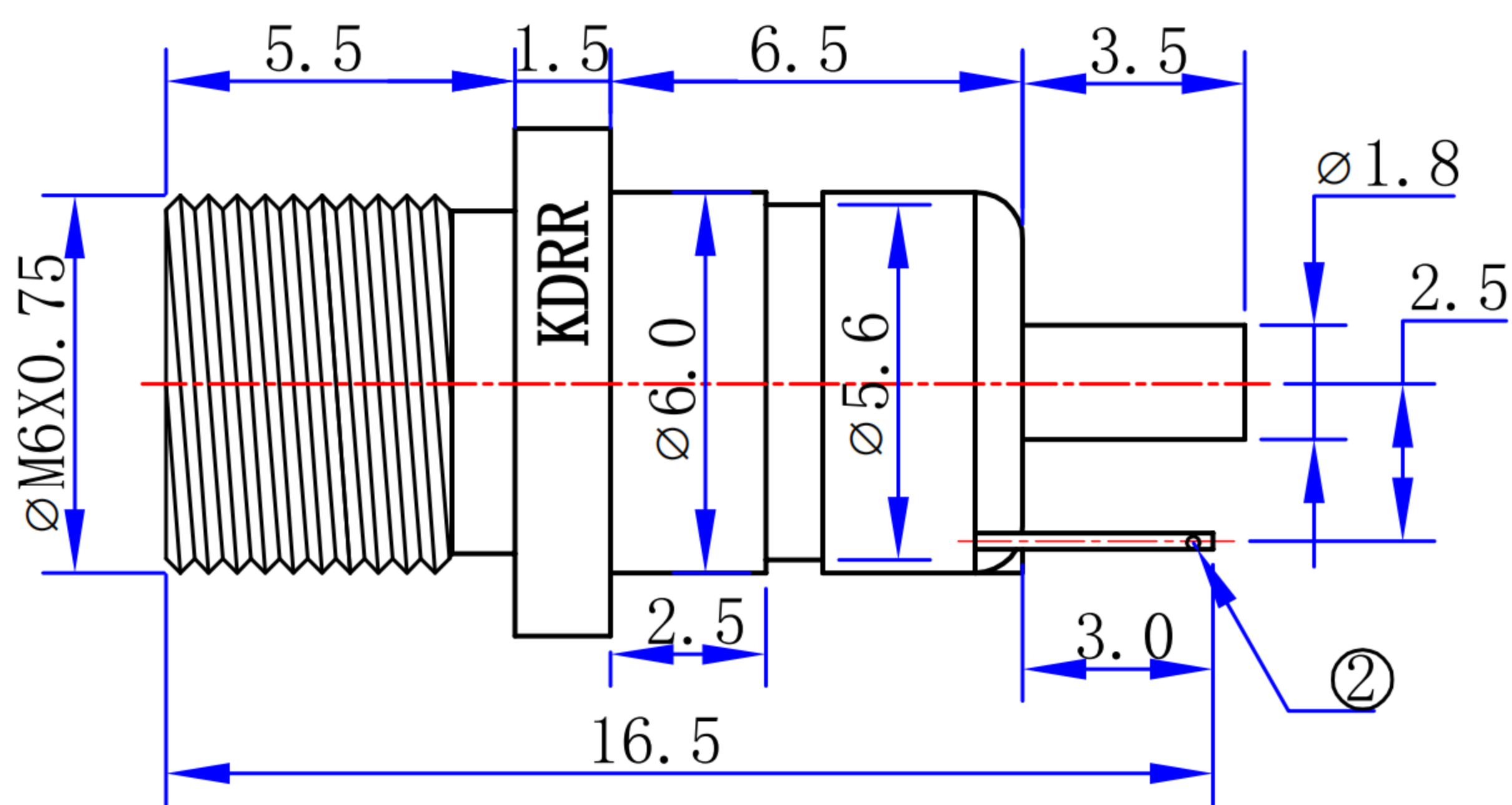
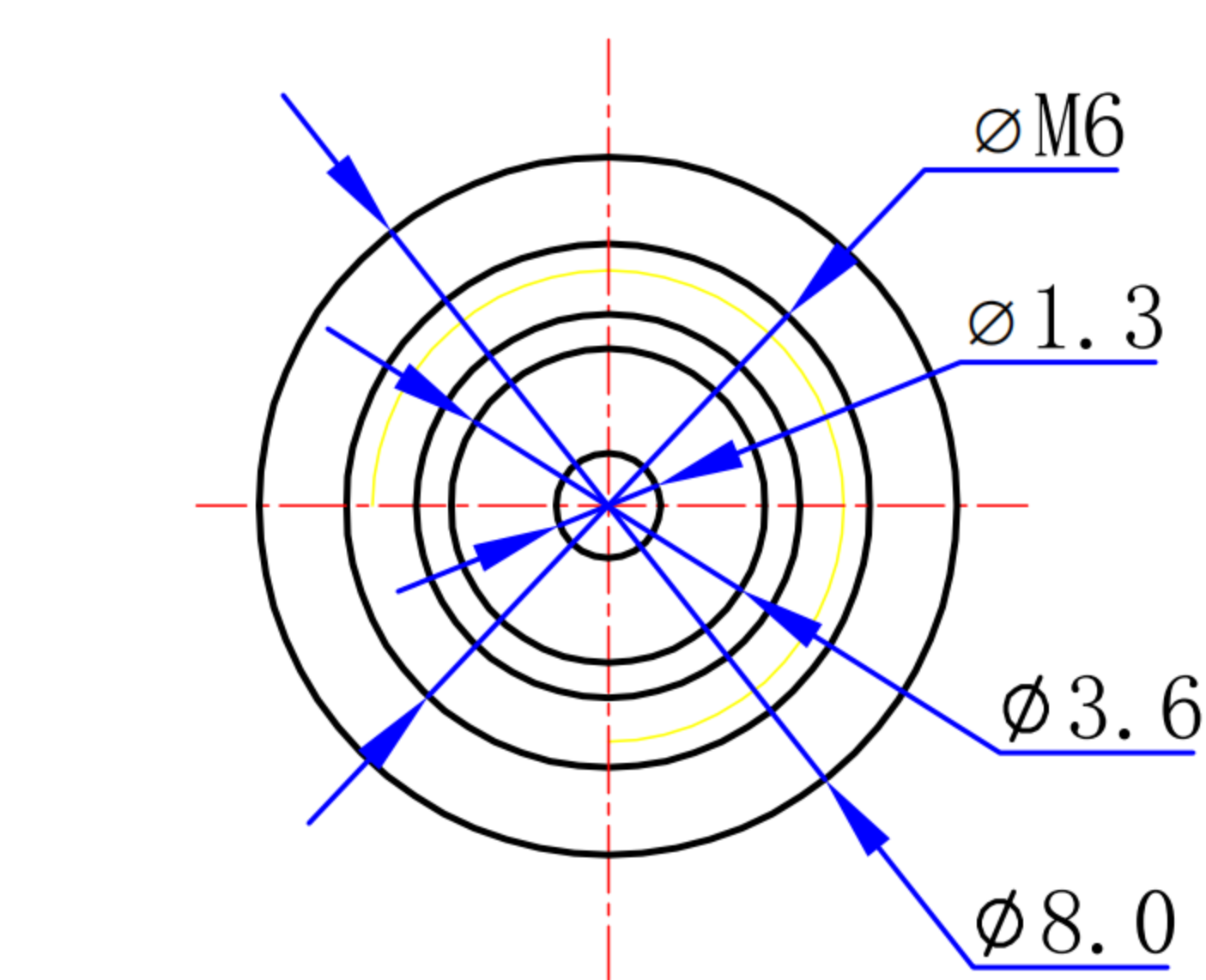
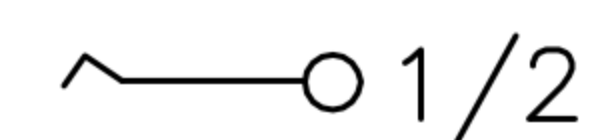
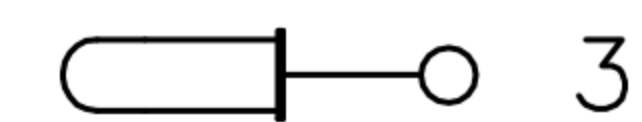

PIN	$\phi 1.3$	$\phi 1.65$
APPD.		

SPECIFICATION

1. Rating : DC 12V 30V , 30A 50A
2. Contact resistance : $\leq 30m\Omega$
3. Insulation resistance : $\geq 100M\Omega$
4. Withstand voltage : 500VAC
5. Insertion and extraction force : 3-20N
6. life test : 5,000 cycles

NO.	DESCRIPTION	QTY	MATERIAL	PLATING
⑥	COVER	1	PF	
⑤	CONTACT FOOT	1	BRASS	Sn-Plating
④	PIN	1	BRASS	Ni-Plating
③	SPRING	1	PHOSPHOR BRONZE	Sn-Plating
②	FLAT PIECE	1	BRASS	Sn-Plating
①	HOUSING	1	PBT	

DC MATE PLUG



TOLERANCE UNLESS OTHERWISE STATED :
 Up to 5 ±0.2
 Above 5 ~ 15 ±0.3
 Above 15 ~ 30 ±0.4
 Above 30 ~ 50 ±0.5
 Angle ±0.3°

3RD. ANGEL'S

UNITS MM

DRAWN BY:	DATE	MAT'L	TITLE	JACK
Ming Ming Zou	6/8/23			
CHECKED BY:	DATE	FINISH	MODLE	DC JACK
Ning Ning Su	6/8/23			
APPROVED BY:	DATE	SCALE	DWG NO.	GD-DC-083E
Jia Xiang	6/8/23	1:1		
SHEET NO.	1 of 1	PART NO.		

ITEM NO.	DESCRIPTION	DRAWN	DATE
4	更新材質	Jack	050420
3	更新尺寸	Jack	121119
2	更新尺寸標示位置	Jack	082719
1	更新尺寸	Jack	080519